

# CONVECTOR HEATER

316664

Kalahari 18

Kalahari 25

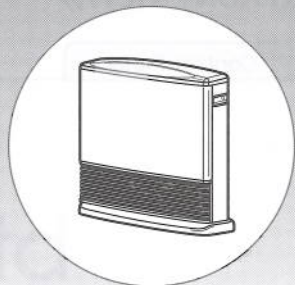

## CUSTOMER OPERATION AND INSTALLATION INSTRUCTIONS

Thank you for purchasing a Rheem Convector Heater

To operate this appliance safely and correctly,  
please read these instructions thoroughly.

Please contact your nearest Rheem distributor if  
these instructions are lost.

### ○ *Timer Function*

*The heater operates automatically  
at the set times.*

### ○ *Economy Function*

*When the room reaches temperature,  
the heater automatically operates  
at 2°C lower to reduce operating costs.*

### ○ *Remote Control Included*

*The heater can be easily operated via  
the Remote Control.*

Product Overview .....	1
Safety Instructions .....	3
Installation Instructions ...	8
How to use your heater:	
Operational Instructions ....	9
Temperature Adjustment Instructions ..	10
OVER-RIDE Function .....	10
Setting Clock .....	11
Programming Timers .....	12
Child Lock .....	15
Care of heater	
Inspection and Maintenance ..	16
Trouble Shooting .....	18
Servicing and Warranty .....	21

# PRODUCT OVERVIEW

## «FRONT VIEW»

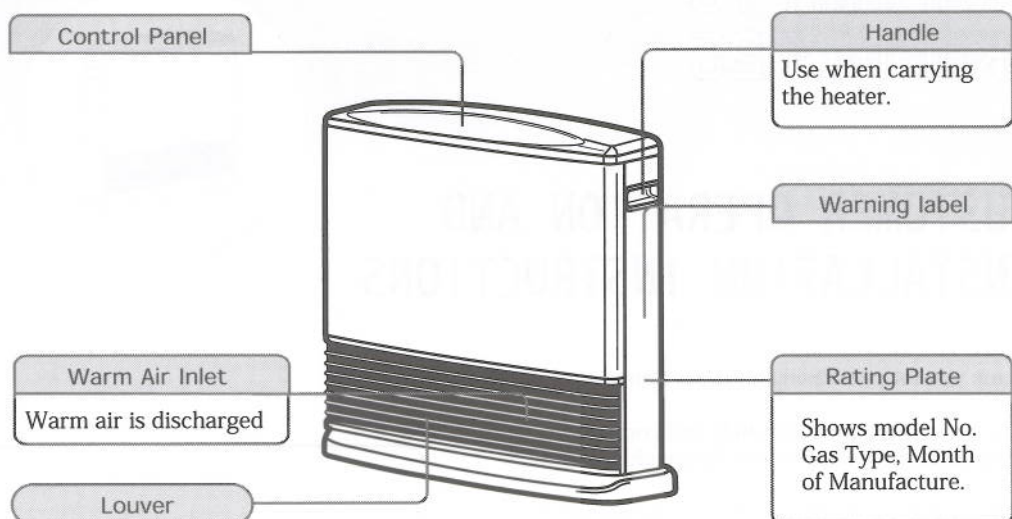

## «Rear View»

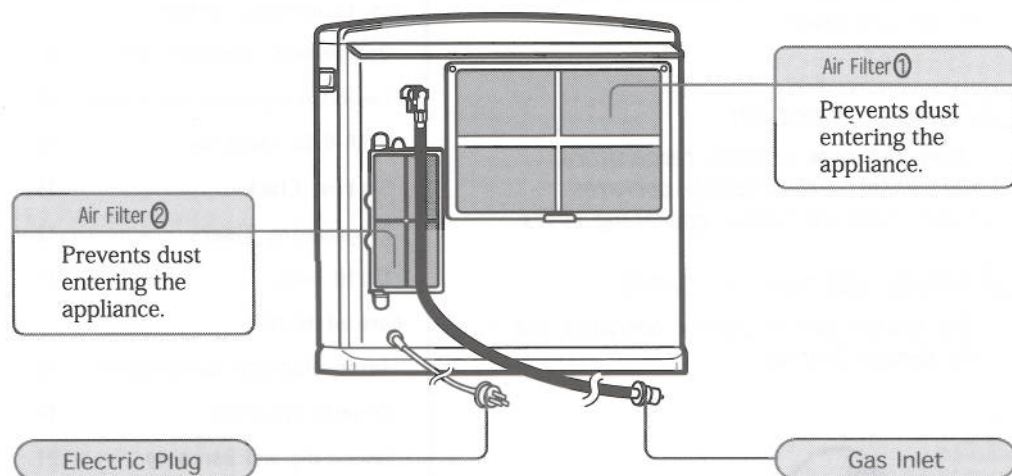

## 《CONTROL PANEL》

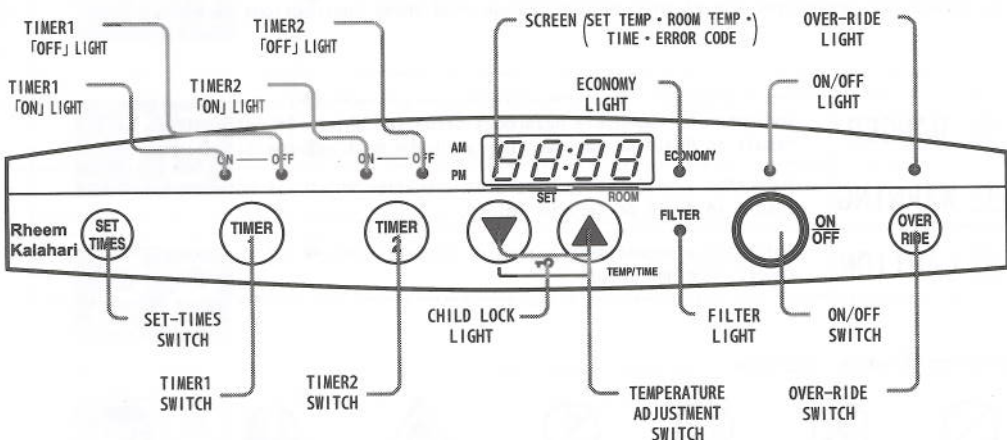

## 《REMOTE CONTROL》

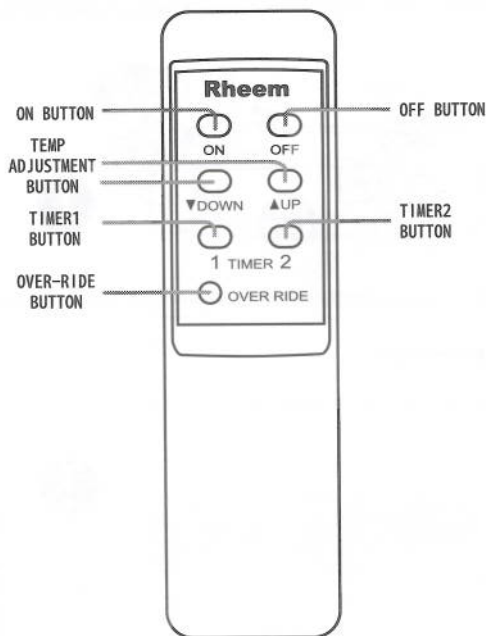

### Replacing battery (AAA size 1.5V 2pieces)

- ① Remove access panel.



- ② Ensure that battery is correctly fitted.

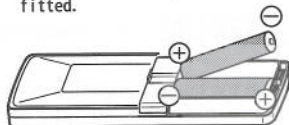



- ③ Replace access panel and gently push into position.



# SAFETY INSTRUCTIONS

## To use this heater safely

To ensure safe and proper use of this heater, please read these instructions carefully.

 <b>DANGER</b>	Indicates an immensely hazardous situation which, if not avoided, will result in death or serious injury in the most extreme situations.
 <b>WARNING</b>	Indicates a potentially hazardous situation which, if not avoided, could result in death or serious injury.
 <b>CAUTION</b>	Indicates a potentially hazardous situation which, if not avoided, may result in minor injury.

Definitions of symbols listed below.



Generally prohibited



No fire to be ignited



Do not touch



Do not dismantle



Be careful of flame



What should be followed



Unplug

### DANGER

if a gas leak is detected do not turn power switches on or off. Do not plug or unplug electrical appliances. Do not use the telephone.

- Flame or spark may ignite the gas and cause fire.
- ① Cease operation immediately and close the gas valve.
  - ② Open windows and doors for ventilation.
  - ③ Contact your nearest Rheem distributor.



### WARNING

Ensure that the heater supplied is correct for the gas type provided.

The appliance gas type is indicated on the rating plate.

→ Using different types of gas may cause an explosive ignition resulting in injury, damage to the heater, or malfunction of Oxygen Depletion Safety Device.

\* If you are uncertain, please contact your nearest sales outlet, Rheem distributor or your gas supplier.

Use 240V AC, 50HZ for electricity supply.



## ⚠ WARNING

Use the hose supplied with the heater to avoid risk of gas leakage.



Ventilation and room size must comply with local regulations.  
Note: Not intended for fireplace insert.



Ensure room has adequate ventilation.

→ Continuous use decreases oxygen level in the room which activates the Oxygen Depletion Safety Device.

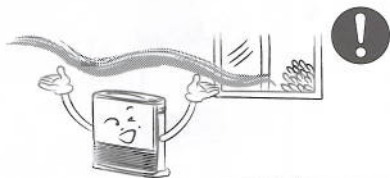

Do not allow curtains or other flammable materials to come into contact with the heater.

→ It may cause fire, or the pressure in the aerosol may rise too high and result in an explosion.



Do not use or store gasoline, benzene, aerosol and other flammable materials near the heater.

→ It may result in fire.



Do not insert paper, cloth or any other foreign materials in the Louvre or the Air Inlet and do not cover them.

→ It may cause a fire or overheating due to blockage or air intake.



Do not place any obstructions in front of the Warm Air Outlet or Air Filter.

→ Outlet air may become too hot and may cause discoloration or cracking.

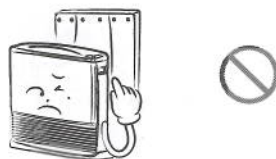

Do not leave the heater unattended.

→ It may result in fire.



Do not stay where direct heat from the heater is received for long hours. Do not sleep directly in front of the heater.

→ Relieving direct heat continuously may affect physical conditions or may cause low temperature burn.

\* The following persons must be supervised at all times.

Infant, Aged, Very Tired, Person with Sensitive Skin, Person who is intoxicated.



## ⚠ WARNING

- ① If the heater does not ignite, or abnormal combustion, odour, noise are observed when in use, cease operation immediately and close the gas valve.
- ② If a problem is observed, refer to the troubleshooting section of these instructions.
- ③ If the problem cannot be fixed then call for service.

Cease operation and close the gas valve immediately in the event of an emergency situation.



## ⚠ CAUTION

Do not move the heater during operation.

→ It may cause gas leakage or abnormal combustion due to damaged or disconnected hose. Also it may cause burn. Damage to hose may occur which could cause a gas leak, abnormal combustion or injury may result.



Only to be used as a space heater.

→ It may cause fire or damage by overheating or abnormal combustion.



Do not touch the warm air outlet as it is hot when in use.

→ It may cause a burn. Please ensure that children are supervised at all time.



This appliance is to be repaired by an authorised person.

→ Repair by an unauthorised person may cause abnormal operation.



Do not place anything in front of the Louvre or block the Air Inlet.

→ Warm air temperature will rise, which may result in fire or discolouration or damage to the floor.



Do not stand, sit or lean on the heater.

→ The heater may be damaged.



Do not insert your finger into the Louvre or the Air Inlet.

→ It may cause injury.



Do not cut the electric cord to extend. Install the heater where the electric cord reaches a wall socket.

→ It may cause fire or injury.



## CAUTION

Do not unplug to shut down during operation.

→ It may cause overheating.

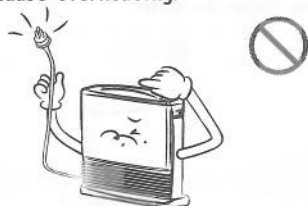

Plug in carefully.

→ If not it may cause electric shock or fire.



Do not touch the electric plug with wet hands.

→ It may cause electric shock.



Do not pull the electric cord.

→ It may cause a fire due to the cord breaking.

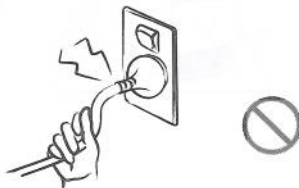

Remove dust from plug

→ If not dusty may ignite.



Do not plug into double adaptor.

→ It may cause a fire due to overheated wall socket.



Do not place near a door.

→ The heater may be knocked over.



Place a flat board for stability when the heater is placed on soft or thick carpet.

→ Placing directly on the carpet may discolour carpet.



## ⚠ CAUTION

Do not install in a greenhouse or a room used by house pets.

→ It may dry up the plant or kill pets.



Do not place the heater where water may splash. Do not place a water container on the heater.

→ It may damage the heater.

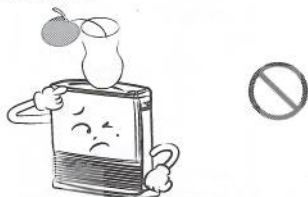

Do not place the heater in front of a step.

→ Warm air may discolour the step.



Ensure that recommended clearances are maintained at all times.

→ It may cause malfunction of temperature control and may cause fire.



Do not place the heater under a plastic light.

→ The plastic cover may become discoloured.



## INFORMATION

This heater is for household use only. Using for commercial application will shorten its life significantly.



In case of a thunder storm, cease operation and unplug the electric cord.



Do not use sprays containing silicon close to the heater. It damages the Oxygen Depletion Safety Device.



Do not install in a place where the heater may be affected by wind. Flame may be blown out by strong wind.





# INSTALLATION INSTRUCTIONS

This appliance is to be installed in accordance with:

- Local gas fitting regulations.
- Municipal building codes.
- NZ Standard 5261/AS5601
- Manufacturer's installation instructions.
- Any other relevant statutory regulation.
- This appliance must be installed, serviced and removed by an authorised person.

## 1 PREPARATION

- ① Unpack and take out the heater.
- ② Make sure that the gas specified on the rating plate matches the supplied gas.
- ③ Do not install if the heater is for wrong gas type. Please contact the place of purchase immediately

## 2 INSTALLATION SITE

Be sure to install on a flat surface and a room of an adequate size.

### ⚠ CAUTION

Do not install in following places.

- A room with inadequate ventilation.
- Where flammable objects are likely to come into contact with the heater.
- Uneven surface.
- Under shelves.
- Windy location.
- In confined space, e.g. inside a fireplace.
- Near a door.
- Where water may splash or near other heat source.
- On vibrating floor.
- In a bedroom or bathroom.
- Caravan, Mobile house or recreational vehicle.

## 3 MINIMUM CLEARANCE

### ⚠ CAUTION

These clearances must be maintained at all times.

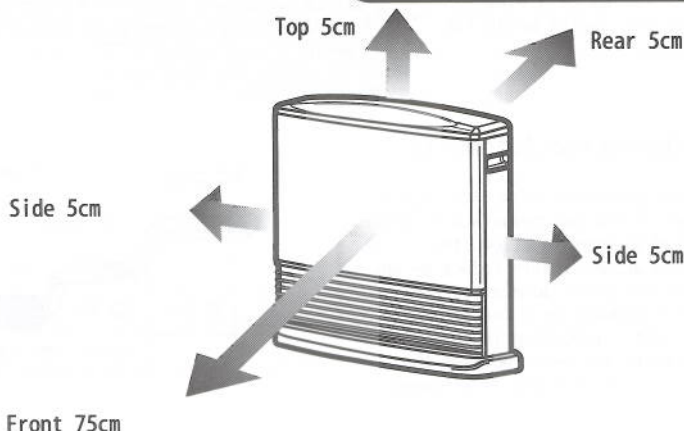

# OPERATIONAL INSTRUCTIONS

## [Control Panel]

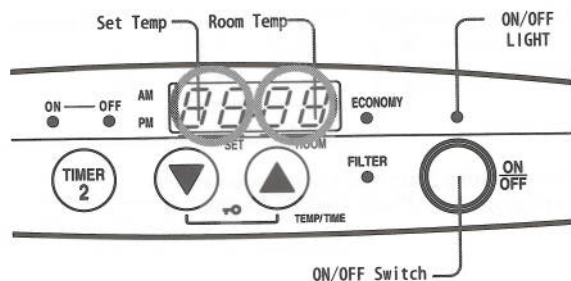

## [Remote Control]

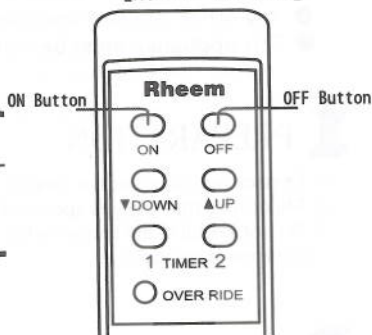

## Operation

### Press ON/OFF Switch

- Press ON/OFF switch
- ON/OFF Light glows green then glows red after burner ignites.
- Set temperature and room temperature are displayed on the screen.
- While the main power light is glowing green the heater can be switched on by pressing the Remote Control on button.

## Turning Off

### Press ON/OFF Switch

- The on Light goes out, press Remote Control OFF button.
- The ON/Off light glows green.
- Clock displayed in green.
- After the heater is turned off the convection fan continues to rotate for up to 4 minutes. Please do not unplug while fan is rotating

## Important Information

- For the first use or after not using for a while, the heater may not light immediately. If the heater does not light, please try to light repeatedly.
- If starting heater after a long period the heater will take longer than usual to light.
- Do not start then stop immediately. It may cause the heater to overheat or filter light to come on.
- Economy operation will not function if the set temperature reaches a temperature in excess of the room temperature.
- The heater will stop after 8 hours of continuous operation except when the timer is used.

## Economy Operation (Automatic)

The economy operation allows the heater to heat the room to the set temperature, after a period of 30 minutes it allows the temperature to automatically reduce by one degree. After a further 30 minutes the temperature is reduced by a further one degree. The subtle reduction in temperature is not noticed by the user, however the reduction in operation costs is welcomed.

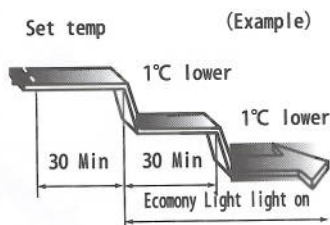

# TEMPERATURE ADJUSTMENT INSTRUCTION

While heater is operating.

- 「SET」 indicates Set temp and 「ROOM」 indicates current Room temp.
- Pre-set "Set temp" is 22°C.
- Set temp is memorized.
- Set temp selection can range from Low(16°C) – High(26°C)
- Room temp indicates 「L」 (lower than 0°C) , 「1」 ~ 「30」 and 「H」 (warmer than 31°C) .

Press  ...To raise the Set Temp

Press  ...To lower the Set Temp

## Caution

- Please assume that the Room Temp is not an exact temperature.
- Room temp may go up beyond Set temp due to room size, installation place and the ambient temperature.  
In this case, please press ON/OFF or OFF switch to turn it off.
- In case of immediate re-operation, Room temp shown on the screen may be higher than actual Room temp for three or four minutes.

# OVER-RIDE INSTRUCTION

OVER-RIDE function allows the user to manually override the preset program to operate the heater.



Press OVER-RIDE switch

### Between Timers

- |                   |     |   |
|-------------------|-----|---|
| Press 「OVER-RIDE」 | ON  | The heater operates while the timers are on hold. |
| Press 「OVER-RIDE」 | OFF | The heater turns off then preset program resumes. |

### During Timer operation

- |                   |     |                                |
|-------------------|-----|--------------------------------|
| Press 「OVER-RIDE」 | ON  | Stop operation.                |
| Press 「OVER-RIDE」 | OFF | The heater will operate again. |

Over-Ride operation is switched on

- OVER-RIDE Light glows.
- After combustion ON/OFF Light glows red.
- Set temp and Room temp will appear on screen.

Over-Ride operation is switched off

- OVER-RIDE Light glows.
- ON/OFF Light glows green and timers are ready.
- After the heater turns off the convection fan continues to rotate for up to 4 minutes. Do not unplug while fan is rotating.

# Setting Clock

1



Press ON/OFF button.

- ON/OFF Light glows.
- Set temp and Room temp are displayed on the screen.

2

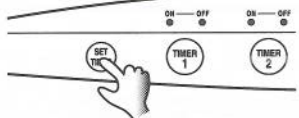

Press SET TIMES button

- Time is displayed.

3



Adjust the time

- If you keep pressing the adjustment button, the display changes by 1 minute from 1~59 minutes then changes by 1 hour from AM12~PM11.

[Example] To adjust to 11:12

- ① Adjust the hour.  
Keep pressing the adjustment button until 11:00AM is displayed.
- ② Adjust the minute.  
Press the adjustment button again until 11:12AM is displayed.

▼ ...lower ▲ ...upper

4

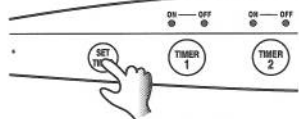

Press SET TIMES five times

- The screen comes back to Set temp and Room temp mode.

5



Press ON/OFF button to exact clock setting mode.

- ON/OFF Light goes out.
- Clock will be shown on the screen.

## Caution

If the heater is unplugged or there is a power failure please reset the time.

# PROGRAMMING THE ON/OFF TIMER(S)

Two timers are available.  
You are able to set the start time and shutdown time.

## Programming the timer

Before programming the Timers please ensure that the correct time is set.

1



Press ON/OFF button

- ON/OFF Light glows.
- Set temp and Room temp are displayed on the screen.

2

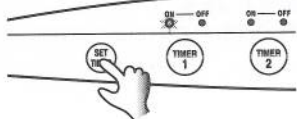

Press SET TIMES button twice.

- The lamp for TIMER 1 ON flashes.
- The TIMER1 time is displayed on the screen.

3



Adjust TIMER 1 operation time.

- If you keep pressing the adjustment button, the display changes by 1 minute from 1~59 minute then changes by 1 hour from AM12~PM11.

**[Example]** To adjust to 5:30 AM

- ① Adjust the hour  
Keep pressing the adjustment button until 5:00 AM is displayed.
- ② Adjust the minute  
Press the adjustment button until 5:30 AM is displayed.

4

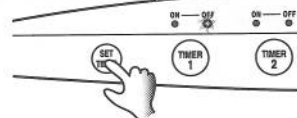

Press SET TIMES button

- TIMER1 OFF lamp flashes.
- TIMER1 time set is displayed on the screen.

5



Adjust TIMER1 shut down time

- If you keep pressing the adjustment button, the display changes by 1 minute 1~59 minutes then changes by 1 hour from AM12~PM11.

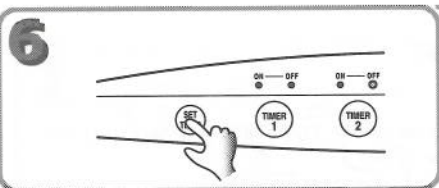

Press SET TIMES button

- TIMER2 ON lamp flashes.
- TIMER2 time set is displayed on the screen.

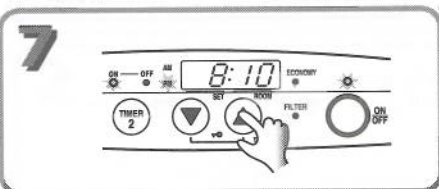

Adjust TIMER2 operation time

- If you keep pressing the adjustment button, the display changes by 1 minute from 1~59 then changes by 1 hour from AM12~PM11.

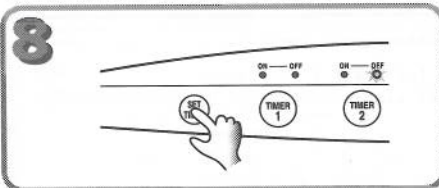

Press SET TIMES button

- TIMER2 OFF lamp flashes.
- TIMER2 OFF set is displayed on the screen.

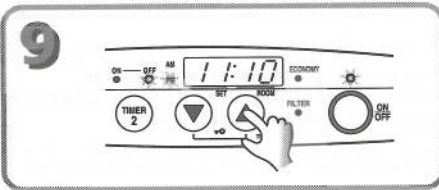

Adjust TIMER2 shut down time

- If you keep pressing the adjustment button, the display changes by 1 minute from 1~59 minute then changes by 1 hour from AM12~PM11.

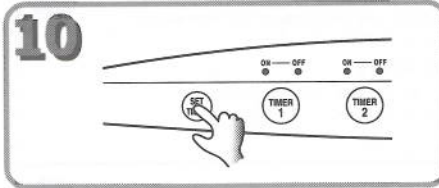

Press SET TIMES button

- This exits SET TIMES mode.
- A display comes back to show Set/Room temp mode.

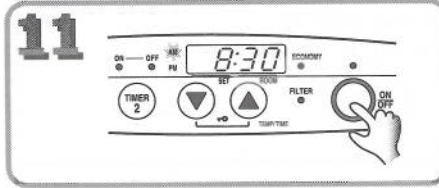

Press ON/OFF button to turn off

- ON/OFF lamp lights.
- The current time will be shown on the screen.

### Caution

- The operation and shut down times for the timers are stored in memory. If the request operation and shut down times for the timers are the same it is not necessary to set up anew

## PRE-HEAT function

This heater has a pre-heat function which operates the heater one hour prior to programmed starting time of the timer. This function will warm the room before the programmed starting time of the timer.

The heater will operate one hour prior to the programmed starting time of the timer.

## Operation of timers

This owners guide provides timer operation via the unit, but it is possible to control the timers by using the remote control.

### 1



Please ensure that main power is ON

- While main power is ON, ON/OFF light glows green or glows red after ignition.

### 2



Please ensure you take the following steps.

- Is the gas valve fully opened?
- Set temp is adjusted to desired temperature?
- There are no objects in front of the Louvre to block the air outlet.

### 3

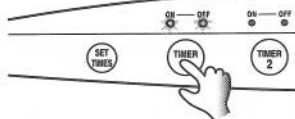

Press the TIMER button

- You can choose only TIMER1 or TIMER2 or both TIMER1 and TIMER2 by pressing the buttons.
- Selected TIMER's 「ON」 「OFF」 lamp glows.
- If during operation, combustion will shut down then ON/OFF light will glow green.

### 4

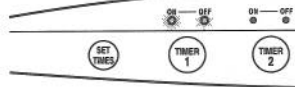

At one hour prior to the setting time the heater will operate automatically

- Selected 「ON」 Light flashes.
- ON/OFF Light turns from green to red.

### 5



Timer operation start timez

- Selected TIMER's 「ON」 「OFF」 Light flash.

6

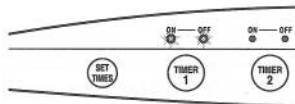

#### 【Timer operation shut down time】

- Selected TIMER's 「ON」 「OFF」 Light glows.
- Combustion shut down and the heater stands by for timer operation.
- ON/OFF Light glows green.

## 6 Cancelling the timers

Press ON/OFF button or OFF switch on remote control or Press the TIMER button.

Cancel the timers and Light will turn off.

(In case The Child Lock function is activated, Unlock and press the buttons to cancel the timers.)

### Caution

- The heater will operate at 26°C automatically, if Set Temp for the timer function is adjusted 「H」 for safety.
- If the electric cord is unplugged or in case of power failure, the Timers will be cancelled. So the selected Timers will not operate.
- You cannot overlap set times between the two timers. If the timers are overlapped, the time that is set first will have priority and the timer set second will be cancelled.
- The timer settings will continue to operate if they are not cancelled.

# Child Lock

This heater has a child lock function which prevents accidental operation as well as children interfering with the controls.

Lock function is activated via the operational panel.

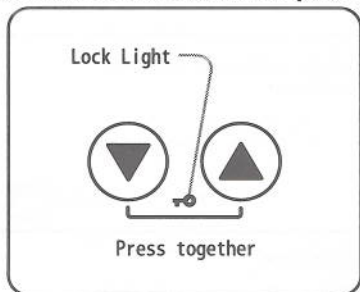

Press adjustment buttons together for one second

- Lock Light glows

● Cancelling the lock

Press adjustment buttons together again

- Lock Light turns off.

If the heater is locked during operation it is only possible to press the ON/OFF button.

If child lock is activated when the heater is not operating, no button on the control panel can be activated.



# INSPECTION AND MAINTENANCE

Disconnect gas hose and turn heater off, unplug and wait until the heater cools down.

- Be sure to carry out daily inspection and maintenance.
- Do not use the heater if you believe something is wrong.
- It is recommended that your heater be serviced periodically.

## Points to check

1. There are no flammable materials in the vicinity of the heater.
2. Air filter is fitted correctly and is not dirty.
3. The hose is correctly connected without kinking or twisting.
4. There is no damage to the electric cord.

## Maintenance

### ⚠ Caution

Wear gloves

→be careful of sharp edges.



### Request

Do not use cleaning cloth, thinner, petrol, acid or alkaline detergent.  
This will avoid discoloration of the paint and plastic components.

## MAINTENANCE OF HEATER OUTER JACKET (preferable to clean once a month)

Keep the heater clean

- Use damp soft cloth to wipe.
- Use mild soapy water for severe dirt.

## MAINTENANCE OF THE LOUVRE

- Use vacuum cleaner to remove dirt on the Louvre. Make sure that fan is not working before cleaning.
- White powder may form on the Louvre. Wipe off with soft cloth.

### ! Caution

Do not press the Louvre heavily, do not apply strong pressure to the Louvre.

→The Louvre may break causing discolouration of the floor or carpet due to the change in heat discharge.

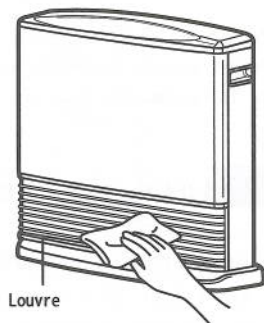

## MAINTENANCE OF THE AIR FILTER

- If the Air Filter lamp flashes, clean Air Filters ① and ②.
- Use vacuum cleaner to remove dirt on the Air filters.
- Air Filter ① could be taken off to clean. Use mild soapy water for severe dirt and refit after drying.
- If Air Filter is wet, the heater may not operate correctly.
- Do not remove Air Filter ②.

### «Remove the filter»

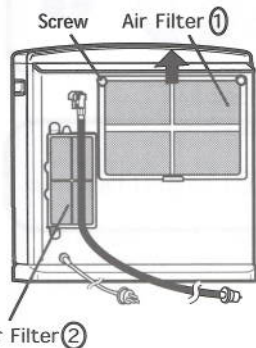

- 1.Remove the Screw
- 2.Hold the upper side of Air Filter ① and pull upward.( Do not hold and pull strongly. It may cause the Air Filter break.)

### «Refit the filter»

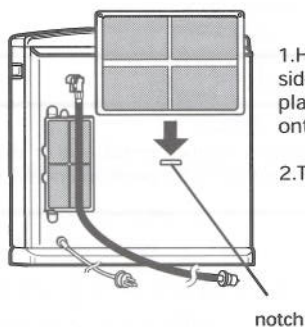

- 1.Hold the upper side of Air-Filter ①, place the filter onto the notch.
- 2.Tighten the screw

### Request

The heater should not be operated without the filter. Please refit filter correctly.

# TROUBLE SHOOTING



## CHECK AS BELOW

FAULT	CAUSE AND REMEDY
Does not operate (ON/OFF Light does not glow green)	<ul style="list-style-type: none"><li>● Electric cord is not fully plugged in.</li><li>● Circuit Breaker or fuse is blown.</li><li>● Power failure.</li><li>● Child Lock is set.</li></ul>
Does not ignite (ON/OFF Light does not glow red)	<ul style="list-style-type: none"><li>● Supply Gas valve is not fully opened.</li><li>● Air in the hose.</li></ul>
Turns off during operation.	<ul style="list-style-type: none"><li>● Air Filter is clogged. (Filter lamp flashes.)</li><li>● Obstruction in front of the warm air outlet.</li></ul>
Room does not become warm enough.	<ul style="list-style-type: none"><li>● Set-temp is set too low.</li><li>● Window or door is opened.</li><li>● Supply Gas valve is not fully opened.</li><li>● Obstruction within 75 cm in front of the heater.</li><li>● Room size does not suit the heater capacity.</li></ul>
Gas smell.	<ul style="list-style-type: none"><li>● The hose is not securely connected.</li><li>● The hose is damaged.</li><li>● Turn off heater. Do not use.</li><li>● Call for service.</li></ul>

Call for a service if any problems other than those described below are observed or if problem persists after taking remedial action.

**THE FOLLOWING IS NOT A FAILURE**

PROBLEM	CAUSE AND REMEDY
The heater does not ignite when using first time in the season, when not used for a long time or when the hose is re-connected.	There is air in the hose. Repeat ignition procedure until the heater ignites (the lamp glows red) to purge the air in the hose.
The heater smells or smokes when using first time or first time in the season.	Oil or dirt trapped in the heater are burnt. Operate the heater while ventilating the room. Paint or floor wax could smell due to being heated.
Noisy during ignition or shut down.	This is normal electric gas valve noise.
Ignition and shut down makes "Bop" noise.	This is a normal operation noise.
The heater makes hissing noise.	This is a normal gas flow noise.
Metal noise is heard after ignition or heater is turned off.	It is normal noise caused by the expansion or contraction of metal panels.
Convection Fan does not stop immediately after shut down.	The fan rotation stops after the heater cools down. (Maximum 4 minutes.)
Does not ignite immediately after shut down.	Please wait until the heater cools down. The heater will re-ignite automatically 20 seconds later.
Does not operate after the heater is accidently unplugged	Please wait until the heater cools down. Try to restart after a few minutes.

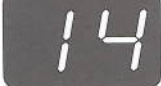
ERROR CODE	CAUSE AND REMEDY
	<ul style="list-style-type: none"> <li>● Gas valve is not fully opened.</li> <li>● The gas supply volume is inadequate.</li> </ul>
	<ul style="list-style-type: none"> <li>● Operate again after room is ventilated.</li> <li>● Clean the Air Filter.</li> </ul>
	<ul style="list-style-type: none"> <li>● The heater tilted or bumped. Place the heater on a stable and level surface and restart.</li> </ul>
	<ul style="list-style-type: none"> <li>● Air filter is clogged. Clean filter and restart.</li> <li>● Louvre is obstructed. Remove obstruction and restart.</li> </ul>

External dimensions propane models ( in mm )

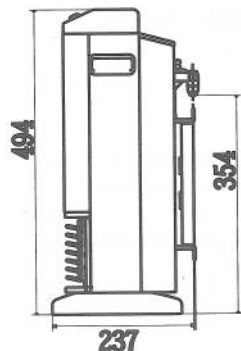
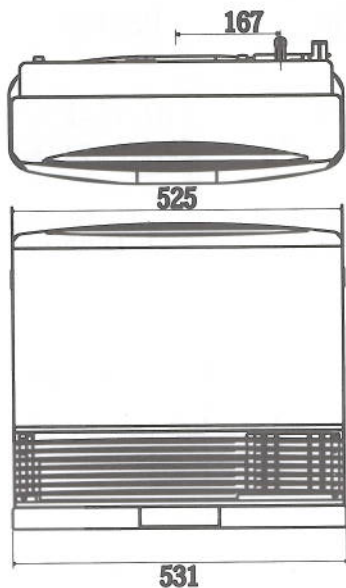

# SERVICING AND WARRANTY INFORMATION

Please record below:

Your Retailer:

Address:

Phone:

Date of Purchase:

There is no need to post this warranty back. Simply keep it with your receipt in a safe place as your record.

	FREE LABOUR PERIOD	FREE PARTS PERIOD
COMBUSTION CHAMBER	3 YEARS	10 YEARS PRO RATA(*)
ALL OTHER PARTS	3 YEARS	3 YEARS

(\*) Combustion chamber full replacement parts cost in the first 3 years, 15% per year thereafter.  
Please note: general cleaning, maintenance and wear and tear are not covered by the warranty. Calls of this nature may be chargeable.

DISTRIBUTED IN NZ BY

**Rheem NZ Ltd**

**475 Rosebank Rd,  
Avondale, Auckland**

**Tel: 09 829 0200**

**Fax: 09 829 0222**