

***Owner's Guide
and
Installation Instructions***



**Domestic Mains Pressure
Electric Storage Water Heater**

EM50 and E80 to E400 Series

*This water heater must be installed and serviced by a qualified person.
Please leave this guide with the householder.*

⚠ Warning: *Upon completion of the installation and commissioning of the water heater, leave this guide with the householder or responsible officer.*

DO NOT leave this guide inside the cover of the water heater, as it may interfere with the safe operation of the water heater or ignite when the water heater is turned on.

Patents

This water heater may be protected by one or more patents or registered designs in the name of Aquamax Australia Pty Ltd.

Trademarks

® Registered trademark of Aquamax Australia Pty Ltd.
™ Trademark of Aquamax Australia Pty Ltd.

CONTENTS

Householder: Read the section “About Your Water Heater” (pages 3 to 16). The “Installation” section is intended for the installer but may be of interest.

ABOUT YOUR WATER HEATER	3
Model Type.....	3
Turning On the Water Heater	6
Shut Down Procedure	6
Temperature Adjustment.....	6
Other Important Information	7
Periodic Maintenance.....	8
Water Chemistry.....	11
Troubleshooting	14
INSTALLATION	16
Installation Overview	16
Water Supplies	18
Plumbing & Plumbing Diagrams	18
Plumbing Connections.....	18
Two Temperature Zones Using a Temperature Limiting Device.....	23
Circulated Hot Water Flow & Return Systems	24
Electrical & Electrical Connections.....	25
Thermostat Adjustment	26
Commissioning.....	27
Draining the Water Heater	28
Dimensions & Technical Data	29
WARRANTY	31

ABOUT YOUR WATER HEATER

Product Application

This water heater is designed for use in a single family domestic dwelling for the purpose of heating potable water. Its use in an application other than this may shorten its life.

Model Type

Aquamax® electric storage water heaters are available with either a single heating unit or with twin heating units (refer to “Single Element Model” and “Twin Element Model” on page 4). The water heater can be installed in an indoor or outdoor position and is not to be used as a pool heater.

Water is stored in a vitreous enamel lined steel cylinder and is heated by an electric immersion heating unit (element). The thermostat controls water temperature whilst automatic safety controls fitted to the water heater provide safe and efficient operation.

Model Selection Chart

50 Litre	80 Litre	125 Litre	160 Litre	250 Litre	315 Litre	400 Litre
EM50S36	E80S18	E125S18	E160S18	E250S24	E315S36	E400S36
EM50S18L	E80S24	E125S24	E160S24	E250S36	E315S48	E400S48
EM50S24L	E80S36	E125S36	E160S36	E250S48	E315T36	E400T36
		E125S48	E160S48	E250T36	E315T48	E400T48
			E160T24	E250T48		
			E160T36			
			E160T48			
			E160S18X			
			E160S24X			
			E160S36X			
			E160S48X			

Note: All models can be supplied with a ‘Hard Water Anode’. These models have the suffix ‘HWA’ at the end of the model number.

Legend

- E or EM (50L Only)** Electric Series 240V AC, 50Hz
- 50, 80, ...,400** Rated hot water delivery in Litres
- S** Single bottom element
- T** Twin element *
- 18, 24, 36, 48** Element wattage (1800W, 2400W, 3600W, 4800W)
- X** Special short version
- L** Fitted with a 240V AC, 10A power supply lead & plug

* Both elements are of the same wattage and are wired for non simultaneous operation.

Single Element Model

This type of water heater has one heating unit with its own thermostat. The heating unit is at the base of the water heater and the unit can be connected to a continuous or off-peak electricity supply. The thermostat is adjustable between 60 ~ 75°C with a factory setting of 65°C (70°C for EM50 models).

- *Continuous electricity supply*

This type of connection is suited to where the storage capacity is less than the normal daily usage.

- *Off-Peak electricity supply*

This type of connection will only allow heating to occur during set hours. A volume of water sufficient for the day's total use is heated and stored. This type of heating will be more economical due to reduced tariffs by the electricity authority.

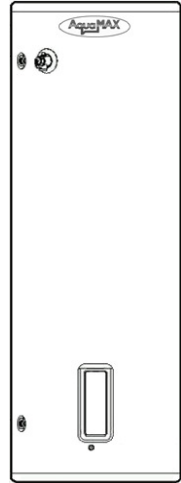

Twin Element Model

This type of water heater has two heating units, each with its own thermostat. One heating unit is at the base of the water heater and the other near the top. The lower thermostat is adjustable between 60 ~ 75°C (factory setting 70°C) whilst the top thermostat is fixed at 60°C.

- *Bottom heating unit (main heating unit)*

During normal operation this heating unit supplies all the hot water.

- *Top heating unit (booster)*

This heating unit only operates during periods of high demand to provide an additional supply of heated water.

- *Electrical connection*

The two heating units are wired for non simultaneous operation so that only one heating unit can operate at a time. The bottom heating unit is usually connected to an Off-Peak (overnight) or time controlled electricity supply and the top heating unit to a continuous supply. Some electricity suppliers allow both heating units to be metered at the Off-Peak or controlled tariff.

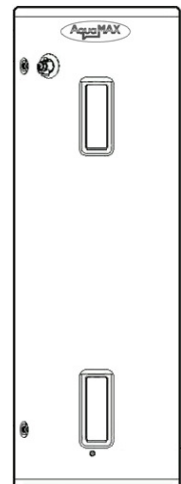

Note: Power must be available to the top heating unit circuit at all times for this water heater to operate as designed.

Mains Pressure Operation

This water heater is designed to operate at mains pressure by connecting directly to the mains water supply. If the mains supply pressure in your area exceeds that shown in “Mains Water Supply” on page 18, a pressure limiting valve must be fitted. The supply pressure should be greater than 350 kPa for true mains pressure operation to be achieved.

Hot Water Temperature

This water heater features an adjustable thermostat which can be set to the most suitable temperature for your hot water needs. Refer to “Temperature Adjustment” on page 6.

To meet the requirements of the National Plumbing Standard and to inhibit the growth of legionella bacteria, the temperature of the stored water must not be below 60°C which is the minimum thermostat setting of the water heater. This is also the top heating unit thermostat setting on a twin element model (the top heating unit thermostat is non adjustable).

The maximum main heating unit thermostat setting is 75°C with a factory setting of 70°C for EM50 and twin element models (top element fixed at 60°C) and a factory setting of 65°C for all other single element models.

High Hot Water Temperature Increases the Risk of Scald Injury

 **Warning:** *This water heater can deliver water at temperatures which can cause scalding. Always check the water temperature before use, such as when entering a shower or filling a bath or basin, to ensure it is suitable for the application and will not cause a scald injury. Aquamax recommends monthly temperature checks to ensure the appropriate temperature is maintained within the hot water heater.*

Aquamax recommends, and it may also be required by regulations, that a secondary device such as an approved temperature limiting device or anti-scald water shut off valve be fitted into the hot water pipe work to the bathroom(s) and ensuite(s) if persons living in the house require additional safety protection from potential scalding. This will keep the hot water supply temperature to the bathroom(s) and ensuite(s) below 50°C which will reduce the risk of scald injury whilst still allowing hotter water (60°C+) to the kitchen and laundry.

For new hot water installations, all sanitary outlet fixtures used primarily for personal hygiene purpose must deliver hot water not exceeding 50°C. This temperature limit is not mandatory for kitchen sinks and laundry tubs and the preferable temperature setting for these outlets should be 60°C.

To minimise scalding, especially for those people in high scald risk categories i.e. young children, people with potentially incapacitating medical conditions, elderly people etc, this water heater must be installed in accordance with AS/NZS 3500.4.

This appliance is not intended for use by persons (including children) with reduced physical, sensory or mental capabilities, or lack of experience and knowledge, unless they have been given supervision or instruction concerning use of the appliance by a person responsible for their safety.

Children should be supervised to ensure that they do not play with the appliance.

For early childhood centres, primary and secondary schools, nursing homes or similar facilities for young, aged, sick or disabled persons, please consult your local health authority for the correct temperature setting.

Turning On the Water Heater

 **Warning:** *The water heater can only be switched on upon completion of the installation by a qualified person.*

To turn on the water heater:

1. Fully open the cold water isolation valve at the cold water inlet to the water heater.
2. Switch on the circuit breaker or isolator marked “Hot Water” or “Water Heater” at the switchboard.

Shut Down Procedure

If it is necessary to turn off the water heater:

1. Switch off the circuit breaker or isolator marked “Hot Water” or “Water Heater” at the switchboard or switch off the water heater isolating switch if one is installed.
2. Close the cold water isolation valve at the cold water inlet to the water heater.

Temperature Adjustment

The thermostat automatically controls the electricity supply to the heating unit so that a constant temperature is maintained within the storage cylinder. The thermostat is fully automatic and power is only used when the water in the storage cylinder requires heating. There is no need to switch the water heater off when it is not in use, except when you are going away for an extended period.

⚠ Warning: *The thermostat and its protective over temperature cut out are mounted inside the front cover(s) of the water heater. The removal of the front cover(s) will expose 240V wiring. Access covers must only be removed by an electrician or qualified person.*

⚠ Warning: *Thermostat temperature adjustment must only be performed by an electrician or qualified person.*

⚠ Warning: *Children should be supervised to ensure they do not interfere with the water heater.*

Other Important Information

Going Away?

If you plan to be away from home for one or two nights, we suggest you leave the water heater switched on. However, if you plan to stay away more than a few nights, conserve energy by switching the water heater off at either the switchboard or isolating switch (if fitted).

Note: When switched back on, the water heater may take 2 ~ 6 hours to reheat depending upon element and water heater size. If connected to an off peak system, hot water may not be available until the following morning.

Safety

This water heater is supplied with a thermostat, an over temperature and energy cut out, and a combination pressure temperature relief valve. These devices must not be tampered with or removed. The water heater must not be operated unless each of these devices are fitted and are in working order.

The Aquamax warranty may not cover faults if relief valves or other safety devices are tampered with or if the installation is not in accordance with these instructions.

⚠ Warning: *For continued safety of this water heater, it must be installed, operated and maintained in accordance with the Owner's Guide and Installation Instructions. These instructions must be read in conjunction with all other instructions affixed to the appliance.*

⚠ Warning: *For models with a power supply lead and plug; take care not to touch the power plug with wet hands.*

⚠ Warning: *For models with a power supply lead and plug; if the power lead is damaged, it must be replaced by an electrician or qualified person in order to avoid a hazard.*

How Long Will the Water Heater Last

The water heater is supported by a manufacturer's warranty (refer to page 31). There are a number of factors that will affect the length of service the water heater will provide. These include but are not limited to the water chemistry, the water pressure, the water temperature (inlet and outlet) and the water usage pattern.

Precautions

Where damage to property can occur in the event of the water heater leaking, the water heater must be installed in a safe tray. Construction, installation and draining of a safe tray must comply with AS/NZS 3500.4 and all local codes and regulatory authority requirements.

The water heater must be maintained in accordance with the Owner's Guide and Installation Instructions. Refer to "Periodic Maintenance" below.

If this water heater is to be used where an uninterrupted hot water supply is necessary for your application or business, you should ensure that you have back up redundancy within the hot water system design. This should ensure the continuity of hot water supply in the event that this water heater was to become inoperable for any reason. We recommend you seek advice from your plumber or specifier about your needs and building back up redundancy into your hot water supply system.

Periodic Maintenance

Minor Six Monthly Maintenance

It is recommended minor maintenance be performed every six months by the dwelling occupant.

 **Warning:** *Exercise care when operating easing levers as water discharged from the water heater may be of a very high temperature.*

Minor maintenance actions:

1. Operate easing lever on pressure temperature relief valve (refer to "Pressure Temperature Relief Valve" on page 9).
2. Operate easing lever on expansion control valve (if ECV fitted) (refer to "Expansion Control Valve" on page 10).
3. If an overflow tray is installed, check to ensure the overflow tray drain pipe is not blocked.

Major Five (5) Year Service

It is recommended a major five (5) year service be conducted on the water heater. Servicing must be performed by a qualified person. Phone Aquamax Service or their nearest Accredited Service Agent.

Note: The five (5) year service and routine replacement of any components, such as the anode and relief valve(s), are not included in the Aquamax warranty. A charge will be made for this work.

Major five (5) year service actions:

1. Replace pressure temperature relief valve.
2. Inspect and flush expansion control valve (if ECV fitted) and replace expansion control valve if required.
3. Inspect anode and replace anode if required. If the anode is not replaced, it should be replaced within three (3) years of this service. Refer to "Anode" on page 10.
4. Check electric heating unit for excessive calcium build up or corrosion and replace heating unit if required.
5. Visually check water heater for any potential problems.
6. Inspect all plumbing and electrical connections.

Note: The water heater will need to be drained during this service and will take some time to reheat the water after servicing has been completed. Depending upon the power supply connection, hot water may not be available until the next day.

Pressure Temperature Relief Valve (PTR valve)

The PTR valve is near the top of the water heater and is essential for safe water heater operation. It is possible for the PTR valve to release a little water through the drain line during each heating period. This occurs as the water is heated and expands by approximately 1/50 of its volume.

Continuous leakage of water from the PTR valve and its drain line may indicate a problem with the water heater (refer to "Pressure Temperature Relief Valve Running" on page 15).

⚠ Warning: *Never block the outlet of the PTR valve or its drain line for any reason.*

Operate the easing lever on the PTR valve once every six months. ***It is very important you raise and lower the lever gently.***

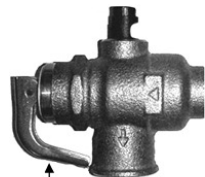

↑
Easing lever

 **Warning:** Exercise care when operating easing lever as water discharged from the water heater may be of a very high temperature.

 **Warning:** Exercise care to avoid any splashing of water, as water discharged from the drain line will be hot. Stand clear of the drain line's point of discharge when operating the valve's lever.

 **Danger:** Failure to perform this procedure may result in the water heater storage cylinder failing.

If water does not flow freely from the drain line when the lever is lifted, then the water heater must be checked. Phone Aquamax Service or their nearest Accredited Service Agent to arrange for an inspection.

The pressure temperature relief valve should be replaced at intervals not exceeding five (5) years, or more frequently in areas where there is a high incidence of water deposits (refer to "Water Chemistry" on page 11).

Expansion Control Valve (ECV)

In many areas, including South Australia, Western Australia and scaling water areas, an ECV is fitted to the cold water supply line to the water heater (refer to the "Cold Water Supply Plumbing Arrangement" diagram on page 19). The ECV may discharge a small quantity of water from its drain line during the heating period instead of the PTR valve on the water heater.

Operate the easing lever on the expansion control valve once every six months. ***It is very important that you raise and lower the lever gently.***

The expansion control valve should be checked for performance or replaced at intervals not exceeding five (5) years, or more frequently in areas where there is a high incidence of water deposits (refer to "Water Chemistry" on page 11).

Anode

The anode installed in your water heater has been designed to slowly dissipate whilst protecting the storage cylinder. If the hot water heater is not used for two (2) weeks or more, a quantity of hydrogen gas, which is highly flammable, may accumulate in the water heater. To dissipate this gas safely, it is recommended that a hot tap be turned on for several minutes or until discharge of gas ceases. Use a sink, basin, or bath outlet, but not a dishwasher, clothes washer or other appliance. During this procedure, there must be no smoking, open flame, or any electrical appliances operating nearby. If hydrogen is discharged through the tap, it will probably make an unusual sound similar to air escaping.

The life of the storage cylinder may be extended by arranging a qualified person to periodically inspect the anode and replace if required. If the anode is not replaced during a five (5) year service (refer to “Major Five (5) Year Service” on page 9) then the maximum time after installation when the anode should be replaced for this electric water heater is eight (8) years.

For water supplies which are either softened, desalinated or where the water supply may alternate between a water tank and a reticulated public supply or another supply, it is recommended the anode be replaced within five (5) years of installation.

Change of Water Supply

The changing or alternating from one water supply to another can have a detrimental effect on the operation and/or life expectation of the water heater storage cylinder, pressure temperature relief valve and heating unit.

Where there is a changeover from one water supply to another, e.g. a rainwater tank supply, bore water supply, desalinated water supply, public reticulated water supply or water brought in from another supply, then water chemistry information should be sought from the supplier or it should be tested to ensure the water supply meets the requirements given in these guidelines for the Aquamax warranty to apply.

Water Chemistry

This water heater must be installed in accordance with this advice to be covered by the Aquamax warranty.

This water heater is manufactured to suit the water conditions of most public reticulated water supplies. However, there are some known water chemistries which can have detrimental effects on the water heater and its operation and/or life expectancy. If you are unsure of your water chemistry, you may be able to obtain information from your local water supply authority. This water heater should only be connected to a water supply which complies with these guidelines for the Aquamax warranty to apply.

Total Dissolved Solids (TDS)

Some water analysis reports may state the conductivity of the water rather than the level of total dissolved solids. Conductivity, measured in microsiemens per centimetre ($\mu\text{S}/\text{cm}$), is directly proportional to the TDS content of the water. TDS, in mg/Litre, is approximately 70% of the conductivity in $\mu\text{S}/\text{cm}$.

The Aquamax warranty will not cover resultant faults to the storage cylinder if this water heater is connected at anytime to a water supply where the TDS content of the water exceeds 600 mg/Litre. In locations where the

water supply TDS exceeds 600 mg/Litre, the magnesium alloy anode (supplied as standard, cap colour code 'Black') should be replaced with an aluminium alloy anode (cap colour code 'Blue'). For more information refer to "Water Chemistry & Anode Type" on page 12.

In locations where TDS approaches 600 mg/Litre, e.g. due to sediment, we strongly recommend fitting an appropriate filter to ensure water entering or in the water heater does not exceed this level at any time i.e. due to sediment build up.

Water Chemistry & Anode Type

Aquamax water heaters are designed to suit the water conditions of most metropolitan supplies, where the Total Dissolved Solids (TDS) content of the supply is less than 600 mg/Litre. For use in regions where the water supply TDS exceeds 600 mg/Litre, the magnesium alloy anode (supplied as standard, cap colour code 'Black') may become excessively reactive. For safety reasons and the longevity of the anode, the magnesium anode should be replaced with an aluminium alloy anode (cap colour code 'Blue') available from your Aquamax supplier. Anode replacement must be carried out by an Aquamax accredited service agent.

⚠ Warning: *If the water supply has a TDS greater than 600 mg/Litre and the anode has not been changed to a blue anode, there is the possibility the anode may become overactive and hydrogen gas could accumulate in the top of the water heater during long periods of no use.*

If the water heater has not been used for two or more weeks, follow the procedure detailed in the "Anode" section on page 10 for safe dissipation of the hydrogen gas build up inside the storage cylinder.

It must be noted that in areas where the TDS exceeds 600 mg/Litre, the Aquamax warranty will not cover resultant faults on components including the storage cylinder that fail due to the bad water conditions even though an aluminium anode is fitted. Refer to "Water Chemistry Levels Affecting Warranty" below for water chemistry levels and components affected.

The life of the water heater may also be extended by periodic inspection of the anode and replacement if necessary (refer to "Periodic Maintenance" on page 8 and "Anode" on page 10).

Water Chemistry Levels Affecting Warranty

The Aquamax warranty of this water heater will not cover resultant faults on components including the storage cylinder where water stored in the storage cylinder exceeds at any time any of the following levels:

Total dissolved solids	600 mg/Litre
Total hardness	200 mg/Litre
Chloride	300 mg/Litre
Magnesium	10 mg/Litre
pH	9.5 and not less than 6.5
Calcium	20 mg/Litre
Sodium	150 mg/Litre
Iron	1 mg/Litre

Scaling Water

Scaling water is water that contains levels of calcium carbonate (total hardness in excess of 200 mg/Litre at any time when the water heater is operating). Scaling water can block and prevent the pressure & temperature relief valve from operating resulting in damage to the water heater storage cylinder and water heater components.

An ECV is mandatory in SA & WA and must be fitted in ALL areas with scaling water to assist in preventing blockage of the pressure and temperature relief valve.

 **Danger:** Failure to install an expansion control valve where scaling water conditions occur may result in the water heater storage cylinder failing.

To avoid damage to the storage cylinder and water heater components, Aquamax strongly recommend scaling water be treated before entering the water heater by fitting appropriate water filters/conditioners etc. Refer to your Local Water Authority for information on water in your area. A build up of white sediment on hot water taps or shower roses can be indicative of scaling water. Contact Aquamax if this condition is observed.

Note: Damage caused by scaling water can affect the Aquamax warranty. (Refer to “Water Chemistry Levels Affecting Warranty” on page 13).

Spring, Dam, Bore & River Water Supplies

The Aquamax warranty of this water heater will not cover resultant faults on components including the storage cylinder due to the effects of sludge and/or sediment as a result of connection to a water supply from silted or treated sources i.e. springs, dams, bores, rivers or towns supplied from a bore.

Troubleshooting

Check the items below before making a service call. If the water heater is within/out of the warranty period you will be charged for attending to any condition or fault that is not related to the manufacture or failure of a part. For warranty terms and conditions (refer to “Warranty” on page 31).

Not Enough Hot Water (Or No Hot Water)

- *Is the water heater’s electricity supply switched on?*

Have your electrician check to ensure the water heater is switched on and that there is electricity at the water heater.

Note: Check the electricity supply to which the water heater is connected. If the water heater is connected to an Off-Peak or time controlled electricity supply, heating hours will be restricted (refer to “Off-Peak Electricity Supply” on page 4).

- *Twin element water heaters*

A twin element non simultaneous model must have power available to the top heating unit circuit at all times for the water heater to operate as designed. Have your electrician check to ensure this is the case.

- *Are you using more hot water than you think?*

Is one outlet (especially the shower) using more hot water than you think? Very often the amount of hot water used is not realised, particularly when showering. Carefully review the family’s hot water usage. Have your plumber fit a flow control valve to each shower outlet to reduce water usage.

- *Pressure temperature relief valve running?*

Is the PTR valve discharging too much water? (Refer to “Pressure Temperature Relief Valve Running” below).

- *Is the thermostat setting correct?*

Ensure the thermostat setting is appropriate. Have your electrician check and adjust the thermostat upwards to gain additional hot water capacity. Refer to “Temperature Adjustment” on page 6.

 **Warning:** Hotter water increases the risk of scald injury.

- *For EM50 models; are the water heaters inlet and outlet connections cross connected?*

Refer to “Left and Right Hand Side Water Connections – EM50 Models” on page 20 for acceptable cold water inlet and hot water outlet connections. Cross connection of the water heaters inlet and outlet connections on EM50 models will result in a reduction of the water heater’s performance.

Pressure Temperature Relief Valve Running

- *Normal Operation*

It is normal and desirable for the PTR valve to allow a small quantity of water to escape during the heating cycle, however there may be a problem if the valve continuously dribbles more than a bucket full of water in a normal 24 hour cycle. **Note:** During the first 24 hours after installation the valve may discharge more than a bucket full of water. This is normal however excess discharge should only occur during the initial 24 hour heat up period.

- *Continuous dribble*

Try gently raising the easing lever on the relief valve for a few seconds (refer to “Pressure Temperature Relief Valve” on page 9). This may dislodge a small particle of foreign matter and clear the fault. Release the lever gently.

- *Steady flows for long period (often at night)*

This may indicate the mains water pressure sometimes rises above the designed pressure of the water heater. Ask your installing plumber to fit a pressure limiting valve.



Warning: *Never use reconditioned relief valves and never replace the relief valve with one of a higher pressure rating.*

- *Heavy flows of hot water until the water heater is cold - then stops until water reheats.*

The water heater **must** be switched off at the isolating switch or switchboard. Phone Aquamax Service or their nearest Accredited Service Agent to arrange for an inspection.

Expansion Control Valve Running

If an expansion control valve is fitted in the cold water supply line to the water heater, it may discharge a small quantity of water instead of the water heaters pressure temperature relief valve. This has the benefit of conserving energy as the discharged water is cooler (refer to the “Cold Water Supply Plumbing Arrangement” diagram on page 19 for expansion control valve location).

Higher Than Expected Electricity Bills

Check the following points if your electricity bill is higher than expected:

- *Is the relief valve running excessively?*

Refer to “Pressure Temperature Relief Valve Running” on page 15.

- *Is one outlet (especially the shower) using more hot water than you think?*
Refer to “Not Enough Hot Water” on page 14.
- *Is there a leaking hot water pipe, dripping hot water tap, etc?*
Even a small leak will waste a surprising quantity of hot water and electricity. Replace faulty tap washers and have your plumber rectify any leaks.
- *Has there been an increase in hot water usage?*
An increase in hot water usage will result in an increase in water heater operation.
- *Has your water heating tariff rate been increased by your electricity retailer since your previous bill?*
The electricity tariff to which your water heater is connected will determine the overall operating cost of the system. It is important you are aware of this tariff, i.e. Off-Peak (overnight) or time controlled supply, Extended Off-Peak (overnight and day) or Extended time controlled supply, Domestic/Continuous. Contact your energy supplier for information relating to your water heating tariff rate.

If you have checked all the previous troubleshooting points and still believe you need assistance, phone Aquamax Service or their nearest Accredited Service Agent.

INSTALLATION

Installation Overview

This water heater must be installed by a qualified person in accordance with the installation instructions. The installation must comply with the requirements of AS/NZS 3500.4, AS/NZS 3000, all local codes and regulatory authority requirements.

All packaging materials must be removed from the water heater prior to its installation. This includes the removal of the cardboard base of the carton from the underside of the water heater.

This water heater is not suitable for pool heating.

Hot Water Redundancy

If this water heater is to be used where an uninterrupted hot water supply is necessary for the application or business, then there should be redundancy within the hot water system design. This should ensure the continuity of hot

water supply in the event that this water heater was to become inoperable for any reason. We recommend you provide advice to the system owner about their needs and building backup redundancy into the hot water supply system.

Water Heater Location

This water heater is suitable for either outdoor or indoor installation. The water heater should be installed close to the most frequently used outlet and its position chosen with safety and service in mind.

Sufficient and safe space for ease of service and access to heating unit, thermostat, sacrificial anode and relief valve should be considered when locating the water heater. The water heater must be installed upright in a vertical position and must be accessible without the use of a ladder or scaffold.

You must be able to read the information on the rating plate. If possible, leave headroom of one water heater height so the anode can be inspected and/or replaced. If adequate room is unavailable, the water heater must be disconnected, drained and removed to enable servicing.

For outdoor installation, the water heater shall be installed freestanding on a level and stable concrete base 50 mm thick.

For indoor installation or where property damage could occur, an overflow tray and drain must be fitted in accordance with AS/NZS 3500.4. The drain pipe from the tray should be periodically checked to ensure that it is not blocked.

Do not install this water heater in a roof space as a mains pressure storage water heater.

Note: Damage to the storage cylinder caused by incorrect installation is not covered by warranty.

Water Supplies

Mains Water Supply

Where the mains water supply pressure exceeds that shown in the table below, an approved pressure limiting valve is required and should be fitted after the stop cock and before the non return valve as shown in the “Cold Water Supply Plumbing Arrangement” diagram on page 19.

Model		EM50, E80, E125, E160	E160X, E250 E315, E400
Pressure temperature relief valve setting		1400 kPa	1000 kPa
Expansion control valve (ECV) setting *		1200 kPa	850 kPa
Max mains supply pressure	With ECV	960 kPa	680 kPa
	Without ECV	1120 kPa	800 kPa

* Expansion control valve not supplied with water heater.

Tank Water Supply

If the water heater is supplied with water from a tank supply and a pressure pump system is not installed, then the bottom of the supply tank must be at least 1 m above the highest point of the hot water plumbing system, including the water heater. Care must be taken to avoid air locks. The cold water supply line to the water heater must be adequately sized and fitted with an approved full flow gate valve or ball valve and non return valve.

Water Supply Chemistry

Bad water can have a detrimental effect on water heater operation, components and life expectancy and may affect warranty. Refer to “Water Chemistry” on page 11 for more information. Also refer to “Spring, Dam, Bore & River Water Supplies” on page 13.

Plumbing & Plumbing Diagrams

Plumbing Connections

All pipe work must be cleared of foreign matter before connection and purged before attempting to operate the water heater. Use thread sealing tape or an approved thread sealant on all fittings (never use hemp).

All Aquamax storage cylinder water fittings have a plastic liner fitted. These liners must be in place for the water heater to function properly. All liners are correctly positioned during manufacture and should not require handling during installation, however if a liner is not

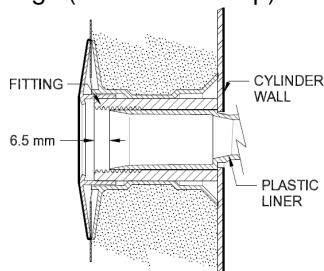

correctly inserted or aligned, it should be gently pushed back into place before connecting any plumbing fittings.

⚠ Warning: Plastic liners must be in place for the water heater to function properly. Do not remove or damage liners.

⚠ Warning: Do not use heat near plastic liners. Heat can be transferred by conduction which may damage liners.

Water Inlet & Outlet Connections

An approved isolation valve and non return valve must be installed in the supply line to the water heater.

A pressure limiting valve and expansion control valve may also be required (for PLV requirements refer to “Water Supplies” on page 18 and for ECV requirements refer to “Expansion Control Valve” on page 20).

A disconnection union must always be provided at the cold water inlet and hot water outlet of the water heater to allow for water heater disconnection.

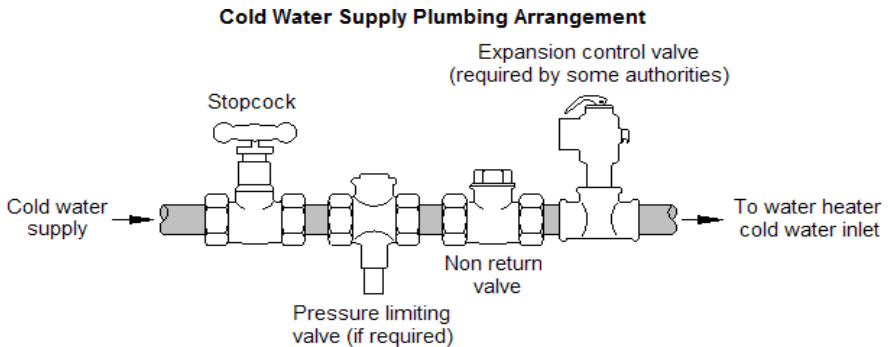

Left & Right Hand Side Water Connections – E80 ~ E400Models

All Aquamax mains pressure electric water heaters are manufactured with dual inlets and outlets. For E80 ~ E400 models, the cold and hot water supply can be connected to either side of the water heater. A kit containing 2 x 3/4" brass plugs is supplied with the water heater to plug off the unused cold and hot water supply fittings. When installing brass plugs, apply thread sealing tape or an approved thread sealant to plug thread before installation.

Left & Right Hand Side Water Connections – EM50 Models

All Aquamax mains pressure electric water heaters are manufactured with dual inlets and outlets. For EM50 series water heaters, the cold and hot water supply can be connected to either side of the water heater however they **must both be connected to the same side** of the water heater. Cross connecting will significantly affect the performance of the water heater and is not permitted. Refer to the diagram below for acceptable plumbing connections.

A kit containing 3 x 3/4" brass plugs is supplied with the water heater to plug off the unused cold and hot water supply fittings and the unused PTR fitting. When installing brass plugs, apply thread sealing tape or an approved thread sealant to plug thread before installation. The PTR valve may be connected to either PTR fitting (centre two fittings in diagram below).

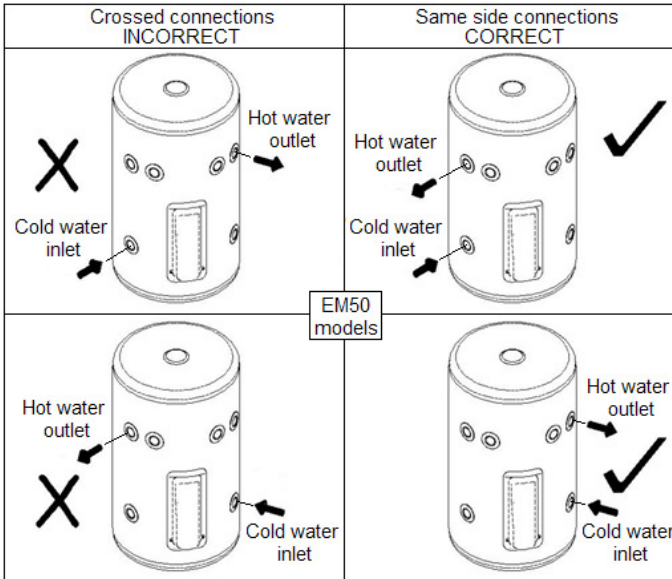

Expansion Control Valve

In some areas, local regulations may make it mandatory to install an expansion control valve (ECV) in the cold water line to the water heater. Refer to “Scaling Water” on page 13.

The ECV must always be installed after the non return valve and be the last valve installed prior to the water heater (refer to the “Cold Water Supply Plumbing Arrangement” diagram on page 19). A copper drain line must be fitted to the ECV (refer to “Relief Valve Drain(s)” on page 21).

Pressure Temperature Relief Valve (PTR valve)

The PTR valve must be fitted before the water heater is operated. Before fitting the PTR valve, make sure the valve probe has not been bent. Seal the valve thread with thread sealing tape (never use hemp) and ensure the tape does protrude past the end of the thread.

For E400 ~ E80 models; screw the PTR valve clockwise into the right hand side opening on the water heater marked "PTR" (refer to E400 ~ E80 Models diagram on page 29) with the valve outlet pointing downwards.

For EM50 models; screw the PTR valve clockwise into either opening on the water heater marked "PTR" (refer to EM50 model diagram on page 30) with the valve outlet pointing downwards.

Do not use a wrench on the valve body – use a spanner on the spanner flats. A copper drain line must be fitted to the PTR valve (refer to "Relief Valve Drain(s)" on page 21).

Relief Valve Drain(s)

DN15 copper drain lines must be fitted to the ECV and PTR valve (if one is installed) to carry the discharge clear of the water heater. Connect the drain lines to the valves using disconnection unions. The drain line from the valve to the point of discharge should be as short as possible, have a continuous fall all the way from the water heater to the discharge outlet and have no tap, valves or other restrictions in the pipe work. A drain line from a relief valve must comply with the requirements of AS/NZS 3500.4.

A drain line must be no longer than 9 metres with no more than three bends greater than 45° before discharging at an outlet or air break. The maximum length of 9 metres for a drain line is reduced by 1 metre for each additional bend required of greater than 45°, up to a maximum of three additional bends. Where the distance to the point of final discharge exceeds this length, the drain line can discharge into a tundish.

Subject to local regulatory authority approval, the drain lines from the ECV and PTR valve from an individual water heater may be interconnected.

The outlet of a drain line must be in such a position that flow out of the pipe can be easily seen, but arranged so discharge will not cause injury, damage or nuisance. The termination point of a drain line must comply with the requirements of AS/NZS 3500.4. Drain lines must not discharge into a safe tray.

In locations where water pipes are prone to freezing, drain lines must be insulated, must not exceed 300mm in length and are to discharge into a tundish through an air gap of between 75mm and 150mm.

If a drain line discharges into a tundish, the drain line from the tundish must be not less than DN20. The drain line from a tundish must meet the same requirements as for a drain line from a relief valve.

⚠ Warning: *As the function of the PTR valve on this water heater is to discharge high temperature water under certain conditions, it is strongly recommended the pipe work downstream of the relief valve be capable of carrying water exceeding 93 °C. Failure to observe this precaution may result in damage to pipe work and property.*

Safe Tray

Where damage to property can occur in the event of the water heater leaking, the water heater must be installed in a safe tray. Construction, installation and draining of a safe tray must comply with AS/NZS 3500.4 and all local codes and regulatory authority requirements. AS/NZS 3500.4 also has particular requirements when a safe tray must be installed.

Pipe sizes

To achieve true mains pressure operation, the cold water line to the water heater should be the same size or larger than the hot water line from the water heater.

Hot water system pipe work must be sized according to the individual application by persons competent to do so. Reference to the technical specifications of the water heater and local regulatory authority requirements must be made.

Pipe Work Insulation

To reduce heat loss, the cold water line to and the hot water line from the water heater must be insulated in accordance with the requirements of AS/NZS 3500.4. The insulation must be weatherproof and UV resistant if exposed.

Saddling Pipe Work

To prevent damage to the storage cylinder when attaching pipe clips or saddles to the water heater jacket, we recommend the use of self drilling screws with a maximum length of 13mm. Should pre drilling be required, extreme caution must be observed when penetrating the jacket of the water heater. If the storage cylinder is damaged as a result of attaching pipe clips or saddles to the jacket, any resultant faults will not be covered by the Aquamax warranty.

Two Temperature Zones Using a Temperature Limiting Device

This water heater can deliver water at temperatures which can cause scalding. It is necessary and we recommend that a temperature limiting device be fitted between the water heater and the hot water outlets in any abluion area such as a bathroom or ensuite, to reduce the risk of scalding.

The installing plumber may have a legal obligation to ensure the installation of this water heater meets the delivery water temperature requirements of AS/NZS 3500.4 so that scalding water temperatures are not delivered to a bathroom, ensuite or other abluion area.

Where a temperature limiting device is installed adjacent to the water heater, the cold water line to the temperature limiting device can be branched off the cold water line either before or after the isolation valve, pressure limiting valve and non return valve to the water heater. If the cold supply branch to the TLD is connected downstream of the water heater non-return valve then we recommend that copper pipe or suitable high temperature plastic pipe be used. This pipe work may be subject to high water temperature and high water pressure. If an expansion control valve is required, it must always be installed after the non return valve and be the last valve prior to the water heater.

If a pressure limiting valve is installed on the cold water line to the water heater and the cold water line to a temperature limiting device branches off before this valve or from another cold water line in the premises, then a pressure limiting valve of an equal pressure setting may be required prior to the temperature limiting device.

Refer to the plumbing diagram “Two Temperature Zones Using a Temperature Limiting Device” on page 23.

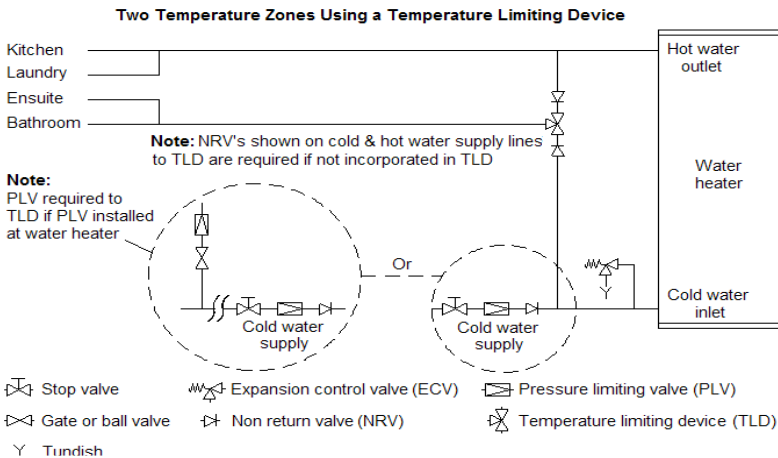

Circulated Hot Water Flow & Return Systems

For circulated hot water flow and return systems, a temperature limiting device can only be installed on a dead leg which branches off the circulated hot water flow and return pipe.

⚠ Warning: *Installing a temperature limiting device in the circulated flow and return pipe work, or circulating tempered water from a temperature limiting device may cause water to be delivered to ablution areas at a temperature exceeding the requirements of AS/NZS 3500.4.*

A single or twin element electric water heater connected to an Off-Peak or time controlled electricity supply should not normally be installed as part of a circulated hot water flow and return system. The benefits of the Off-Peak electricity supply will be significantly reduced and the hot water temperature may not be maintained. If a circulated flow and return system is required, it is necessary to install a secondary (booster) water heater which is connected to the hot water flow and return line and supplied from the Off-Peak electric water heater. Aquamax EM50 model water heaters are suitable for use as the secondary water heater provided it has been determined that hot water demand can be met (the secondary water heater has been suitably sized) and the EM50 thermostat has been set to 70°C to meet the requirements of AS 3498. **Note:** The EM50 thermostat factory setting is 70°C to deliver 60°C.

For Continuous and Off-Peak circulated hot water flow and return plumbing arrangements, refer to the “Circulated Flow & Return Plumbing Diagrams” on page 25.

Circulated Flow & Return Plumbing Diagrams

Circulated Hot Water Flow & Return System - Continuous Electric Water Heater

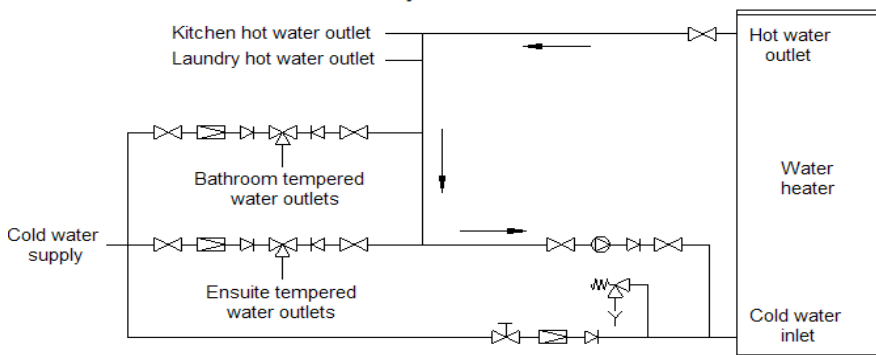

⊘ Stop valve

⚙ Expansion control valve (ECV)

⊞ Pressure limiting valve (PLV)

⊘ Gate or ball valve

⊘ Non return valve (NRV)

⊘ Temperature limiting device (TLD)

⊘ Circulating pump

⊘ Tundish

Note: NRV's shown on cold & hot water supply lines to TLD's are required if not incorporated in TLD

Circulated Hot Water Flow & Return System - Off-peak / Time Controlled Electric Water Heater

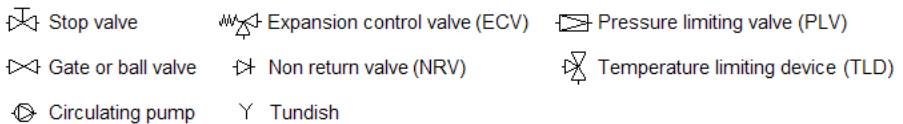
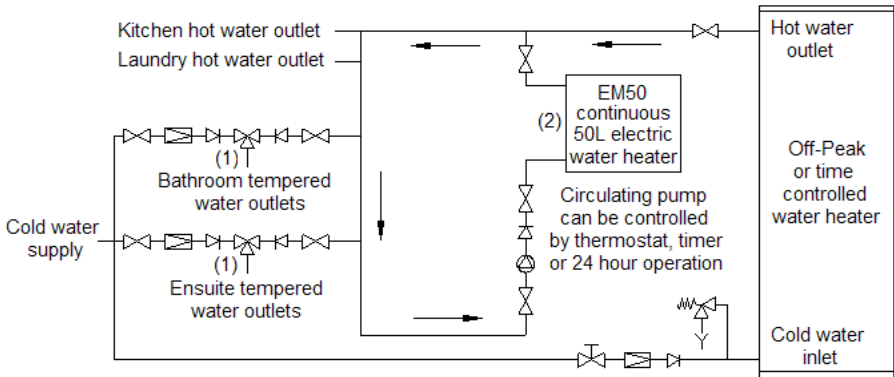

Notes:

- (1) NRV's shown on cold & hot water supply lines to TLD's are required if not incorporated in TLD.
- (2) EM50 thermostat must be set at 70°C to deliver 60°C.

Electrical & Electrical Connections

⚠ Warning: The power supply to the water heater must not be switched on until the water heater is filled with water and a satisfactory megger reading is obtained.

All electrical work must be carried out by a qualified person in accordance with AS/NZS 3000, AS/NZS 3008 and any local authority requirements.

E80 ~ E400 models & EM50 models without a power supply lead & plug: The water heater must be directly connected to a dedicated 240V AC, 50Hz mains power supply with over current protection and an isolating switch installed at the switchboard. The power supply wires insulation temperature rating and current carrying capacity must be suitable for this application.

The power supply to a twin element model should be Off-Peak (overnight) to the bottom heating unit and continuous to the top heating unit. The power supply to a single element model can be either an Off-Peak (overnight), Extended Off-Peak (overnight and day) or continuous electricity supply, depending upon the size of the water heater. Check with the local electricity supply authority as to their requirements. An Off-Peak (overnight)

power supply will provide the maximum financial savings. Discuss the power supply requirements with the householder.

Connect the power supply wires directly to the water heaters terminal block and earth tab connection as shown in the wiring diagram provided on the rear of the lower electrical access cover. Ensure there are no excess wire loops inside the front cover.

Note: The active wire from the continuous supply must be connected to the top heating unit circuit and the active wire from the Off-Peak or time controlled supply must be connected to the bottom heating unit circuit.

A 20mm flexible conduit is required to protect the wiring to the water heater. The conduit is to be connected to the water heater with an approved 20mm flexible conduit terminator.

Note: Remove yellow warning label from conduit entry before connecting conduit and wiring.

EM50 models with a power supply lead and plug: The water heater must plug into a 240V AC 10A general purpose outlet (GPO), which is connected to a 240V AC, 50Hz mains power supply. Models installed outdoors or in areas subject to water ingress must have a weatherproof GPO with an IP rating suitable for the area in which it is installed.

Wiring Diagram

Refer to wiring diagram located behind water heater access cover.

Thermostat Adjustment

 **Warning:** *The thermostat and its protective over temperature cut out are mounted inside the front cover(s) of the water heater. The removal of the front cover(s) will expose 240V wiring. Access covers must only be removed by an electrician or qualified person.*

 **Warning:** *Thermostat temperature adjustment must only be performed by an electrician or qualified person.*

The main (bottom) thermostat has been factory preset to 70°C for EM50 and twin element models and 65°C for all other single element models. It is possible to adjust this thermostat (60 ~ 75°C) but is recommended that the main thermostat's maximum setting does not exceed 70°C.

The boost (top) thermostat is set to 60°C and is non adjustable.

To adjust the main thermostat:

 **Warning:** *The thermostat must only be adjusted when power to the water heater is isolated.*

1. Switch off electrical supply to the water heater. This can be performed at the switchboard or water heaters isolating switch if one is installed.
2. Remove lower access cover.
3. Turn thermostat temperature adjustment dial clockwise to increase temperature setting or anticlockwise to decrease temperature setting.
4. Replace lower access cover.
5. Switch on electrical supply to water heater.

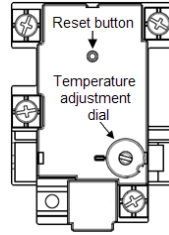

⚠ Warning: *The power supply to the water heater must not be switched on until the water heater is filled with water and a satisfactory megger reading is obtained.*

Over Temperature & Energy Cut Out

The operation of the over temperature and energy cut out on the thermostat indicates a possibly dangerous situation. If the over temperature and energy cut out operates, it must not be reset and the water heater must be serviced by a qualified person.

Commissioning

After installation and before commissioning the water heater the following pre commissioning procedure must be performed:

1. Check to ensure that all wiring links and electrical connections are secure and tight.
2. To ensure the over temperature and energy cut out is set, press and release the black reset button on the thermostat(s) (refer to diagram in “Thermostat Adjustment” on page 26).
3. Perform a megger (insulation) test on the water heater. If a satisfactory megger reading is obtained the water heater can be filled and turned on.

To Fill & Turn ON the Water Heater

⚠ Warning: *The power supply to the water heater must not be switched on until the water heater is filled with water and a satisfactory megger reading is obtained.*

1. Open all hot water taps in premises including shower(s).
2. Fully open cold water isolation valve on cold water line to water heater. This will purge air from hot water plumbing lines via the taps opened in step 1.

3. Close each hot water tap after all air is purged (when air is purged water will run freely without air bubbles or spluttering).
4. Check all plumbing connections for leaks.
5. Switch on electrical supply to water heater and switch on water heater isolating switch (if one is installed).

Explain to the householder, or a responsible officer, the functions and operation of the water heater.

Leave this guide with the householder or responsible officer upon completion of the installation and after commissioning.

To Turn OFF the Water Heater

Sometimes it is necessary to turn off the water heater after installation and commissioning. This may be required on a building site or where the premises are vacant.

To turn off the water heater:

1. Switch off electrical supply to the water heater. This can be performed at the switchboard or water heaters isolating switch if one is installed.
2. Close cold water isolation valve on cold water line to water heater.

Draining the Water Heater

 **Warning:** *Water discharged from the water heater during this procedure may be of a very high temperature. Wear personal protective equipment (PPE) to reduce the risk of scalding.*

To drain the water heater:

1. Switch off electrical supply to water heater. This can be performed at the water heaters isolating switch if one is installed.
2. Close cold water isolation valve on cold water line to water heater.
3. Close all hot water taps in premises.
4. Operate PTR valve lever for a period of five (5) seconds to release pressure in water heater. **Note:** Operate lever gently and do not let lever snap back or you will damage relief valve seat.
5. Undo union at cold water inlet to water heater and attach a hose to water heater side of union. Run other end of hose to a drain.
6. Operate PTR valve lever until all water has drained from water heater. Operating PTR valve lever will let air into the water heater which will allow water to drain through hose.

Dimensions & Technical Data

E80 ~ E400Models

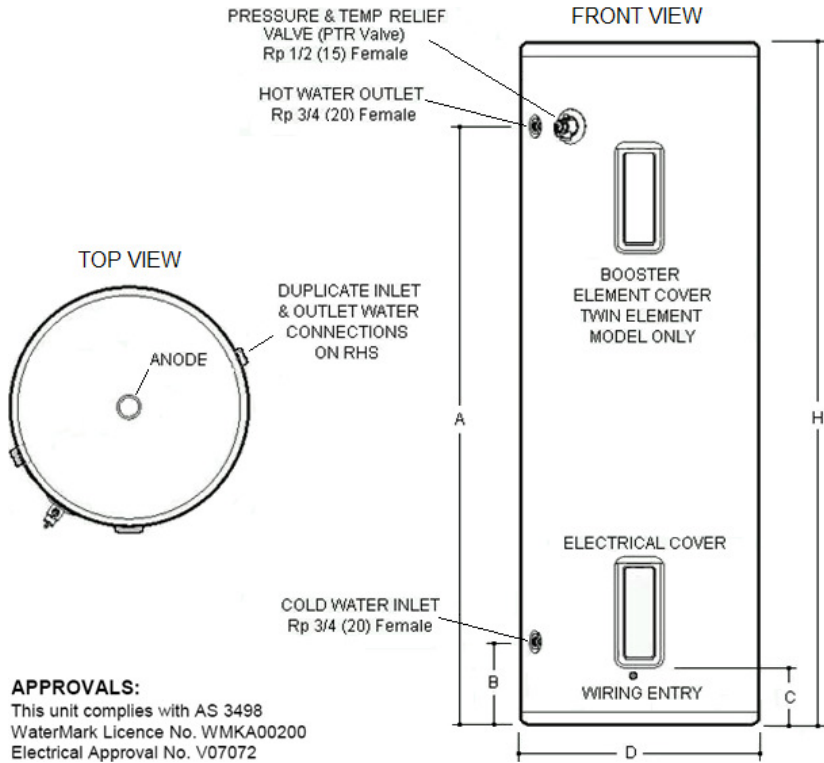

APPROVALS:

This unit complies with AS 3498
WaterMark Licence No. WMKA00200
Electrical Approval No. V07072

Model	E80	E125	E160	E160X	E250	E315	E400
Hot Water Delivery (L)	80	125	160	160	250	315	400
Weight Empty (kg)	35	52	60	60	75	90	100
Dimensions							
A (mm)	680	1090	1410	755	1215	1535	1525
B (mm)	190	190	190	215	215	215	230
C (mm)	100	100	100	125	125	125	140
D (mm)	487	487	487	620	620	620	685
H (mm)	875	1285	1605	975	1435	1755	1760
Max supply Pressure							
With ECV (kPa)	960	960	960	680	680	680	680
Without ECV (kPa)	1120	1120	1120	800	800	800	800
ECV setting (kPa)	1200	1200	1200	850	850	850	850
PTR Valve (kPa)	1400	1400	1400	1000	1000	1000	1000

Technical data is subject to change.

EM50 Models

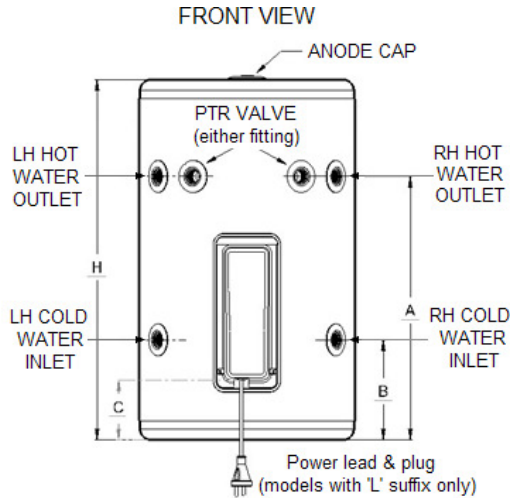
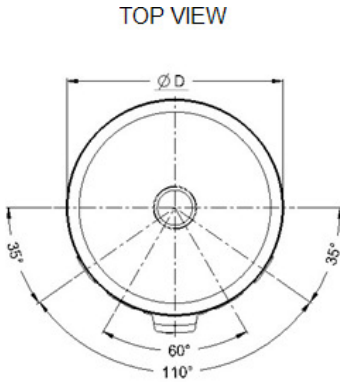

APPROVALS:

This unit complies with AS 3498
 WaterMark Licence No. WMKA00200
 Electrical Approval No. V07072

⚠ Cold water inlet and hot water outlet connections must be made on the same side i.e. right hand connected or left hand connected. Cross connecting will significantly affect performance and is not permitted.

Hot Water Delivery (L)	50	Connections	
Weight Empty (kg)	23	Cold water inlet	RP ³ / ₄ /20
Power lead & plug	Refer to diagram	Hot water outlet	RP ³ / ₄ /20
Dimensions		PTR valve	RP ¹ / ₂ /15
A (mm)	490	Max supply Pressure	
B (mm)	185	With ECV (kPa)	960
C (mm)	105	Without ECV (kPa)	1120
D (mm)	400	ECV setting (kPa)	1250
H (mm)	670	PTR Valve (kPa)	1400

Technical data is subject to change.

WARRANTY

AQUAMAX ELECTRIC DOMESTIC MAINS PRESSURE WATER STORAGE HEATER WARRANTY – AUSTRALIA ONLY-

1. THE AQUAMAX WARRANTY - GENERAL

- 1.1 This warranty is given by Aquamax Australia Pty Limited, ABN 37 138 189 689 of 463-467 Warrigal Road, Moorabbin Victoria.
- 1.2 Aquamax offer a trained and qualified service network who will repair or replace components at the address of the water heater subject to the terms of the Aquamax warranty. Aquamax Service, in addition can provide preventative maintenance and advice on the operation of your water heater. The Aquamax Service contact number is available 7 days a week on 1800 676 000 from 9am to 5pm, excluding public holidays (hours subject to change without notification).
- 1.3 For details about this warranty, you can contact us on 1800 676 000 or by email at service@aquamax.com.au (not for service bookings).
- 1.4 The terms of this warranty is set out in section 2 and apply to water heaters manufactured after 1st September 2012.
- 1.5 If a subsequent version of this warranty is published, the terms of that warranty will apply to water heaters manufactured after the date specified in the subsequent version.

2. TERMS OF AQUAMAX WARRANTY AND EXCLUSIONS TO IT

- 2.1 The decision of whether to repair or replace a faulty component is at Aquamax's sole discretion.
- 2.2 If you require a call out and we find that the fault is not covered by Aquamax warranty, you are responsible for our standard call out charge. If you wish to have the relevant component repaired or replaced by Aquamax, that service will be at your cost.
- 2.3 Where a failed component or cylinder is replaced under this warranty, the balance of the original warranty period will remain effective. The replacement does not carry a new Aquamax warranty.

- 2.4 Where the water heater is installed outside the boundaries of a metropolitan area as defined by Aquamax or further than 25 km from either a regional Aquamax branch office or an Accredited Aquamax Service Agent's office, the cost of transport, insurance and travelling between the nearest branch office or Aquamax Accredited Service Agent's office and the installed site shall be the owner's responsibility.
- 2.5 Where the water heater is installed in a position that does not allow safe or ready access, the cost of that access, including the cost of additional material handling and/or safety equipment, shall be the owner's responsibility. In other words, the cost of dismantling or removing cupboards, doors or walls and the cost of any special equipment to bring the water heater to floor or ground level or to a serviceable position is not covered by this warranty.
- 2.6 This warranty only applies to the original and genuine Aquamax water heater in its original installed location and any genuine Aquamax replacement parts.
- 2.7 The Aquamax warranty does not cover faults that are a result of:
- a. Accidental damage to the water heater or any component (for example: (i) Acts of God such as floods, storms, fires, lightning strikes and the like; and (ii) third party acts or omissions).
 - b. Misuse or abnormal use of the water heater.
 - c. Installation not in accordance with the Owner's Guide and Installation Instructions or with relevant statutory and local requirements in the State or Territory in which the water heater is installed.
 - d. Connection at any time to a water supply that does not comply with the water supply guidelines as outlined in the Owner's Guide and Installation Instructions.
 - e. Repairs, attempts to repair or modifications to the water heater by a person other than Aquamax Service or an Aquamax Accredited Service Agent.
 - f. Faulty plumbing or faulty power supply.
 - g. Failure to maintain the water heater in accordance with the Owner's Guide and Installation Instructions.
 - h. Transport damage.
 - i. Fair wear and tear from adverse conditions (for example, corrosion)
 - j. Cosmetic defects.

- 2.8 Subject to any statutory provisions to the contrary, this warranty excludes any and all claims for damage to furniture, carpet, walls, foundations or any other consequential loss either directly or indirectly due to leakage from the water heater, or due to leakage from fittings and/or pipe work of metal, plastic or other materials caused by water temperature, workmanship or other modes of failure.
- 2.9 If the water heater is not sized to supply the hot water demand in accordance with the guidelines in the Aquamax water heater literature, any resultant fault will not be covered by Aquamax warranty.

3. WHAT IS COVERED BY AQUAMAX WARRANTY FOR THE WATER HEATERS DETAILED IN THIS DOCUMENT

- 3.1 Aquamax will repair or replace a faulty component of your water heater if it fails to operate in accordance with its specifications as follows:

What components are covered	The period in which the fault must appear in order to be covered	What coverage you receive
All components	Year 1	Repair and/or replacement of the faulty component, free of charge, including labour.
The cylinder (if the water heater is installed in a single-family domestic dwelling)	Year 2 to 5	Replacement cylinder, free of charge. Installation and repair labour costs are the responsibility of the owner.
The cylinder (if the water heater is <u>not</u> installed in a single-family domestic dwelling)	Year 1	Repair and/or replacement of the faulty component, free of charge, including labour.

4. ENTITLEMENT TO CLAIM UNDER THIS WARRANTY

- 4.1 To be entitled to make a claim under this warranty, you need to:
- a. Be the owner of the water heater or have consent of the owner to act on their behalf.
 - b. Contact Aquamax Service without undue delay after detection of the defect and, in any event, within the applicable warranty period.
- 4.2 You are not entitled to make a claim under this warranty if your water heater:
- a. Does not have its original serial numbers or rating label.
 - b. Is not installed in Australia.

5. HOW TO MAKE CLAIM UNDER THIS WARRANTY

- 5.1 If you wish to make a claim under this warranty, you need to:
- a. Contact Aquamax on 1800 676 000 and provide owner's details, address of the water heater, a contact number and date of installation of the water heater or if that's unavailable, the date of manufacture and serial number (from the rating label on the water heater).
 - b. Aquamax will arrange for the water heater to be tested and assessed on-site.
 - c. If Aquamax determines that you have a valid warranty claim, Aquamax will repair or replace the water heater in accordance with this warranty.
- 5.2 Any expenses incurred in the making of a claim under this warranty will be borne by you.

6. THE AUSTRALIAN CONSUMER LAW

- 6.1 Our goods come with guarantees that cannot be excluded under the Australian Consumer Law. You are entitled to a replacement or refund for a major failure and for compensation for any other reasonably foreseeable loss or damage. You are also entitled to have the goods repaired or replaced if the goods fail to be of acceptable quality and the failure does not amount to a major failure.
- 6.2 The Aquamax's warranty (set out above) is in addition to any rights and remedies that you may have under the Australian Consumer Law.

INSTALLER INFORMATION

DEAR INSTALLER,

Please provide the following information upon completion of the installation. This information should be provided to Aquamax to assist the customer in the event that a claim is made under the Aquamax warranty.

Plumber (Name & Company):

Plumber's licence number:

Compliance Certificate:

(if applicable in your state)

Installation date:

Model & serial number:

Water Heater date of manufacture:



AQUAMAX AUSTRALIA PTY. LTD	FOR SERVICE TELEPHONE
ABN 37 138 189 689	1800 676 000
www.aquamax.com.au	

NOTE: Every care has been taken to ensure accuracy in preparation of this publication. No liability can be accepted for any consequences, which may arise as a result of its application.

Revision Date: 20/09/2012

AQ0901015-G